

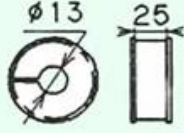

9

# 給電線支持金物用ゴム

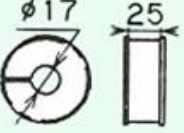
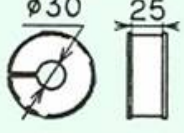
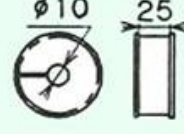

### 使用ゴム一覧表(φ36)

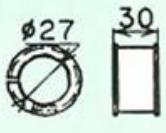
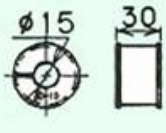
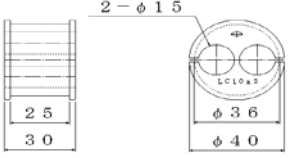
在庫	コード番号	図番	略図	適用
	69189000	YM-9189		10D-2W
	69162000	YM-9162		IS-84-10D LC10<MC> WF-H50-4
	69073000	YM-9073		IS-84-20D LC20<MC> IV-21-1 WF-H50-7
	69194000	YM-9194		LC8
	69194300	YM-9194-C		LC8 × 2
有	69194100	YM-9194-A		AD-20D LHPX-20D WF-H50-7S
有	69194200	YM-9194-B		AD-10D LHPX-10D WF-H50-4S
	ゴム無し			VE28 別添付YM-9094 CDNO.69094000 が必要
	YM-9194F01-01	YM-9194F1-1		LC10 × 2 LHPX-10D × 2 WF-H50-4S × 2

使用ゴム一覧表(φ48) 1/2

在庫	コード番号	図番	略図	適用
	YM-5002	YM-5002		11GHz方形 WRJ-10
	65306100	YM-5306		11GHz楕円
	69168000	YM-9168		HF-20D WF-H50-7
	69169000	YM-9169		HF-10D CVVS WF-H50-4
	69185000	YM-9185		LDF-5-50A LHPX-20D WF-H50-7S
	69187000	YM-9187		IS-84-10D LC10<MC> WF-H50-4
	69184000	YM-9184		HE130
	69184010	YM-9184-A		12GHz方形 WRJ-120
	64001000	YM-4001		LDF-4-50A アンドリユー10D 15GHz円形 LHPX-10D WF-H50-4S
	64000000	YM-4000		15GHz円形 WRJ-140

使用ゴム一覧表(φ48) 2/2

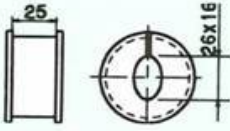
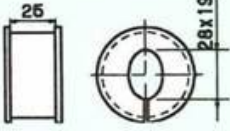
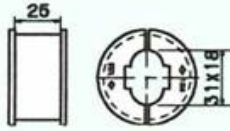
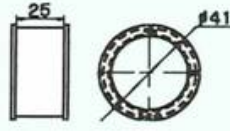
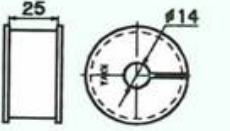
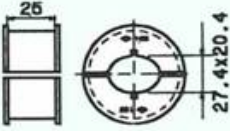
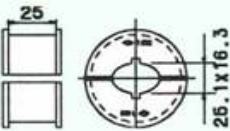
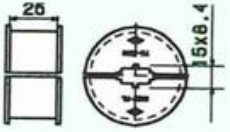
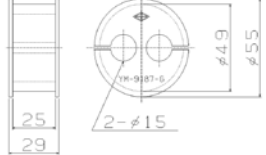
在庫	コード番号	図番	略図	適用
	69184030	YM-9184-C		HE-150
	69178000	YM-9178		WOC-120
	65400000	YM-5400		12GHzまゆ形
	61899000	TC-1899		LC29D LHPX-29D
	69172000	YM-9172		10D-2W
	64009000	YM-4009		15GHz楕円
	64015100	YM-4015		WOC-150 WEJ-151 15GHzまゆ形
	64200000	YM-4200		20GHz方形
	69187070	YM-9187-G		10D × 2 LHPX-10D × 2 WF-H50-4S × 2

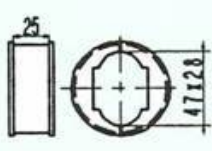
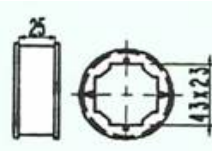
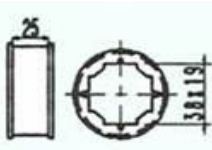
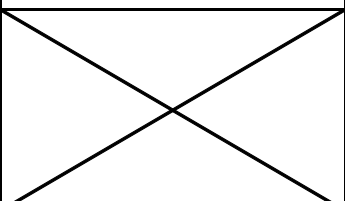
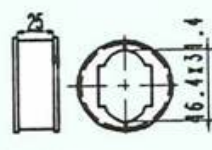
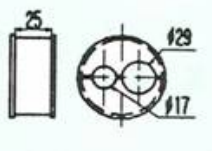
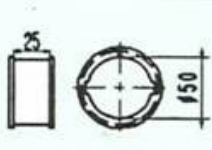
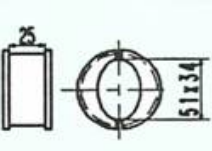
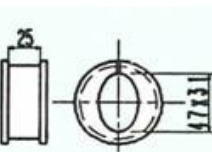
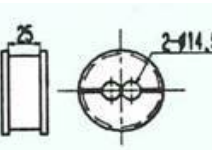

# 使用ゴム一覧表(φ60) 1/2

在庫	コード番号	図番	略図	適用
有	69171000	YM-9171		HE-70
	66002100	YM-6002		6GHz方形 WRJ-6
	65501100	YM-5501		7GHz方形 WRJ-7
	ID973	-		WOC-70
	65511000	YM-5511		7GHz楕円
	69170000	YM-9170		HF-10D/20D
	69107000	YM-9107		IS-84-39 LC39<MC> WF-H50-13
	66308000	YM-6308		6GHz楕円
	69180000	YM-9180		HE-68
	69176000	YM-9176		アンドリュウ 10D × 2 LHPX-10D × 2 WF-H50-4S × 2

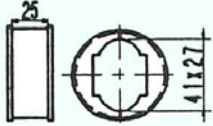
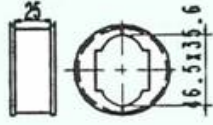
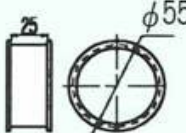
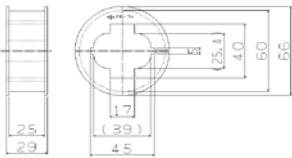
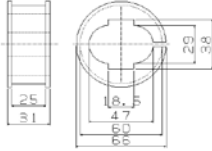
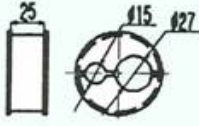
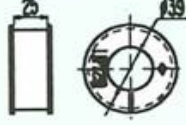
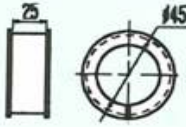
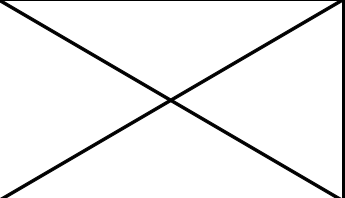
使用ゴム一覧表(φ60) 2/2

在庫	コード番号	図番	略図	適用
	69177000	YM-9177		HE-80 WRJ-9
	65507000	YM-5507		7GHz楕円
	69184500	YM-9184-E		複合ケーブル 55φ
	65516100	YM-5516		7GHz 長尺かとう形 FR-7H
	YM-5518M01-01	YM-5518M1		WRJ-7 FR-6U
	69186001	YM-9186		アンドリュウ 10D/20D
	69175000	YM-9175		LC29D LHPX-29D
	69184700	YM-9184-G		複合ケーブル 45φ
	ID088	-		HE65 WRJ-7

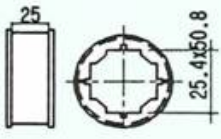
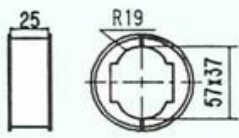
### 使用ゴム一覧表(φ70)

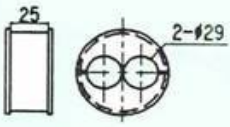
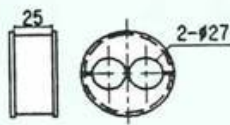
在庫	コード番号	図番	略図	適用
	64502100	YM-4502		5GHz方形 WRJ-5
	64512000	YM-4512		5GHzまゆ形
	69056000	YM-9056		39D-56 φ
	69164000	YM-9164		HF-20D × 2 国産20D × 2 WF-H50-7 × 2
	69181000	YM-9181		LDF-5-50A × 2 LHPX-20D × 2 WF-H50-7S × 2

## 使用ゴム一覧表(φ84)

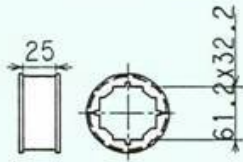
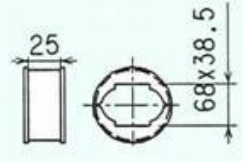
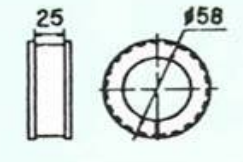
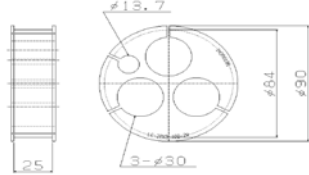
在庫	コード番号	図番	略図	適用
	66502100	YM-6502		4GHz方形 WRJ-4
	66820000	YM-6820		4GHzまゆ形
	69184400	YM-9184-D		複合ケーブル 58φ
	69187300	YM-9187-C		LC20 × 3 LDF-5-50A × 3 LHPX-20D × 3 WF-H50-7S × 3